



Don-Jo Wall Bumpers

1400

1" Diameter

With Anchor Screw - Cast Brass

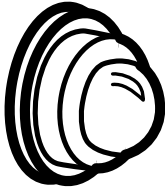

Stocked Product

1400 - 613, 626
1406 - 625
1407 - 619

1406

2 1/2" Diameter

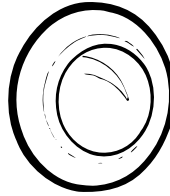

Plastic Anchor & Plastic Dry Wall Anchor
Wrought Material

1407

2 1/2" Diameter

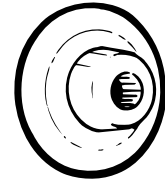

Floor Stops

1440

Low Style

1/8" H x 1 3/4" Diameter Base

W/S & MS & Exp Shield & Plastic Anchor

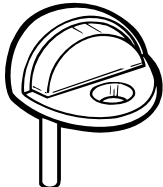

Stocked Product

1440 - 619
1442 - 619

1442

High Style

3/8" H x 1 3/4" Diameter Base

W/S & MS & Exp Shield & Plastic Anchor

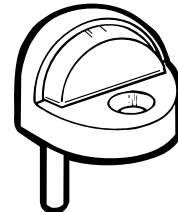

Door Holder

1467

5" Projection

Solid Brass Material

SMS Fastener

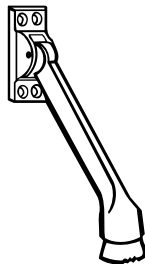

Stocked Product

1467 - 605, 613, 626



Don-Jo

Push & Pull Plates, Pull Handles

35 Door Pull

5 1/2" CTC

• Dimensions - Overall x Projection x Clearance

7 1/2" x 1 7/8" x 1 1/2"

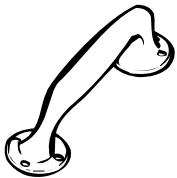

Stocked Product

- 35 - 605, 613, 630
- 70 - 605
- 71 - 605, 613, 629, 630
- 7015 - 605, 613, 630
- 7115 - 605, 629

70,71 Push Plate

70 - 3 1/2" x 15"

71 - 4" x 16"

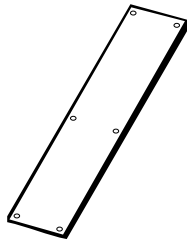

7015, 7115 Pull Plate

7015 - 3 1/2" x 15"

7115 - 4" x 16"

6" CTC

3/4" diameter pull

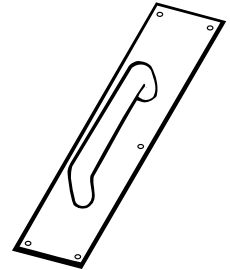

Strikes

9234

2 3/4" x 1 1/8"

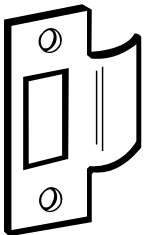

ST161

4 7/8" x 1 1/4"

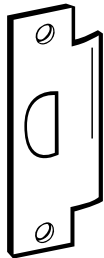

ST214

2 1/4" x 1 1/4"

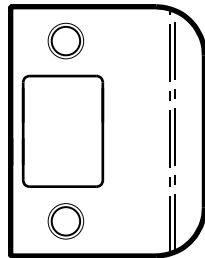

Stocked Product

- 9234 - 605, 630
- ST161 - 605, 613, 626
- ST214 - 605, 630

2-SDS

4 7/8" x 1 1/4"



TS-100-CP Thimble strike

1" Diameter



Stocked Product

- 2-SDS-BP (Steel Brass Plated)
- 2-SDS-SL (Steel Silver Coated)
- TS-100-CP (Chrome Plated)



Don-Jo - *Extended Lip Strikes*

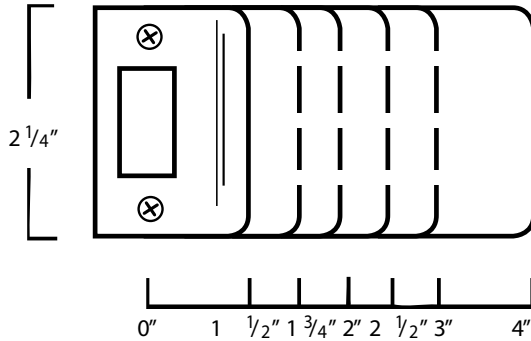

2-1/4" Extended Lip Strike

Number	Dimension
EL102	2-1/4" X 2"
EL115	2-1/4" X 1-1/2"
EL125	2-1/4" X 2-1/2"
EL175	2-1/4" X 1-3/4"

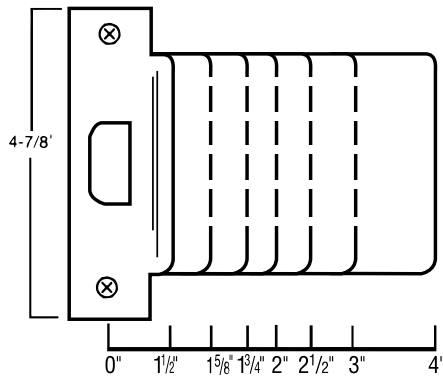

4-7/8" Extended Lip ANSI Strike

Number	Dimension
EST102	4-7/8" X 2"
EST115	4-7/8" X 1-1/2"
EST125	4-7/8" X 2-1/2"
EST158	4-7/8" X 1-5/8"
EST175	4-7/8" X 1-3/4"

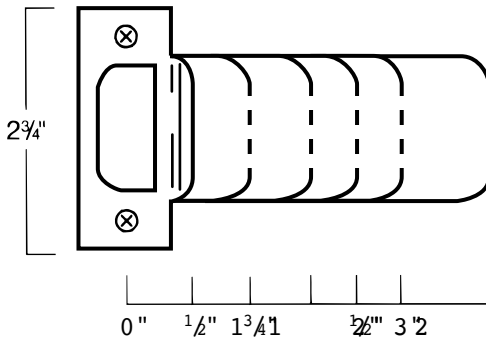

2-3/4" Extended Lip T-Strike

Number	Dimension
ETS102	2-3/4" X 2"
ETS115	2-3/4" X 1-1/2"
ETS125	2-3/4" X 2-1/2"
ETS175	2-3/4" X 1-3/4"

Stocked Product

2-1/4" Extended Lip Strike

EL102 - DU, 605, 619, 630
 EL115 - DU, 605, 619, 630
 EL125 - DU, 630
 EL175 - DU, 605, 619, 630

4-7/8" Extended Lip ANSI Strike

EST102 - 630
 EST115 - 630
 EST125 - 630
 EST158 - 630
 EST175 - 630

2-3/4" Extended Lip T-Strike

ETS102 - 630
 ETS115 - 630
 ETS125 - 630
 ETS175 - 630



Don-Jo - Architectural Accessories

AR335630

Use with levers on 1 3/8" door
(2 per pack)
3-1/2" Diameter
Finish - 630

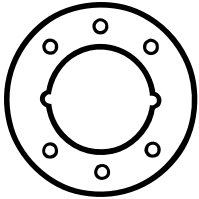

BF161SL

Covers up to 2 1/8" Hole
2-5/8" Diameter
Finish - Silver Coated

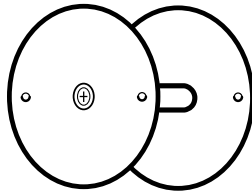

BF178SL

Covers up to 1 1/2" Hole
1-7/8" Diameter
Finish - Silver Coated

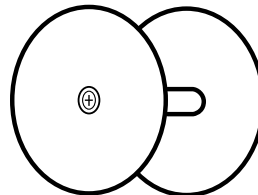

CV86PC

Converts 86
Cut out to 161
8" x 1-1/4"
Finish - Prime Coated



DSP135630

Scar Plate
Fits under Deadbolt
Collars 3-1/2" OD, 1-1/2" ID
Finish 630

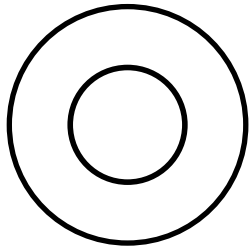

EF86PC

86 cut out
8" x 1 1/4" x 3/16"
Finish - Prime Coated

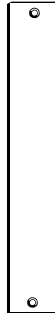

EF161

Filler Plate
2-1/4" x 1-1/8"

EF161SPC

Filler Plate
2-3/4" x 1-1/8"
Cut out
Finish - Prime Coated

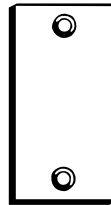

FF45PC

Frame hinge cut out
4-1/2" x 1-5/8"
Finish - Prime Coated

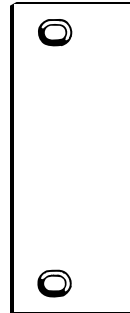

FS260PC

ANST strike cut out
Finish - Prime Coated
4-7/8" X 1-1/4"

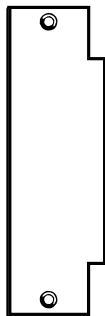

HF45PC

Door hinge cut out
4-1/2" x 1-3/4"
Finish - Prime Coated

SHF45PC

4-1/2" x 1-1/2"
Finish - Prime Coated

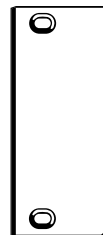

HS060

16 (.060) Gauge Hinge shime

HS090

13 (.090) Gauge Hinge shime
Finish - Prime Coated

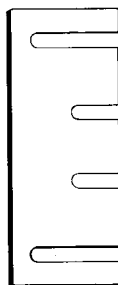

SP135630

Scar Plate
Fits under Rose or
Key in knob or Deadbolt
3-1/2" OD, 2-1/8" ID
Finish 630

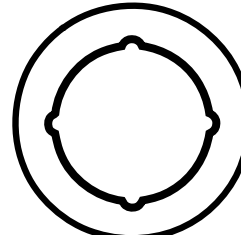

TB215

TAB
Finish - Zinc Plated
1" X 1-1/2"

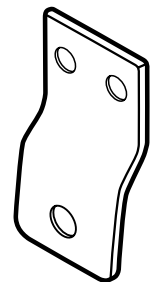



Don-Jo - Remodel Plates

RP-13509

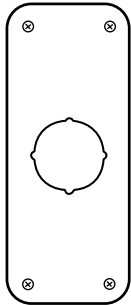

RP-13509-2

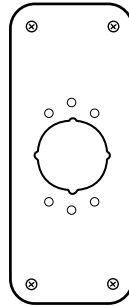

RP-13515

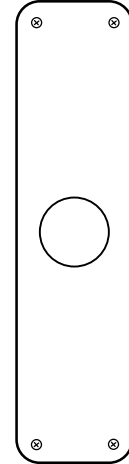

RPK-109

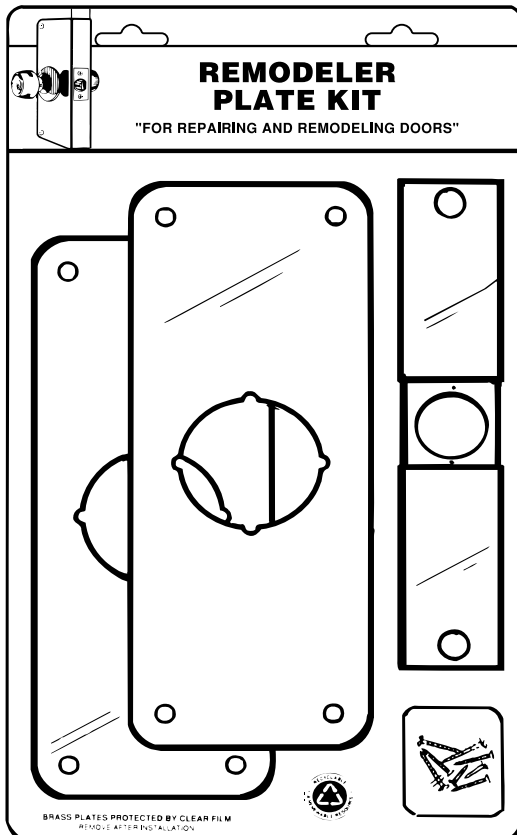

RP-13545

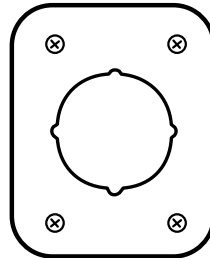

RP-13545-2

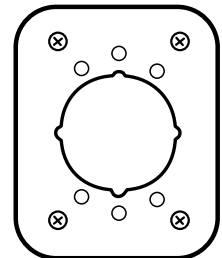

Stocked Product

Item	Size	Finishes
RP-13509	3-1/2" x 9"	630 (stainless)
RP-13509-2	3-1/2" x 9"	630 (stainless)
RP-13515	3-1/2" x 15"	630 (stainless)
RP-13545	3-1/2" x 4-1/2"	630 (stainless)
RP-13545-2	3-1/2" x 4-1/2"	630 (stainless)
RPK-109	3-1/2" x 9"	605 (polished brass) 630 (stainless steel)



Don-Jo Lock Guard Plates

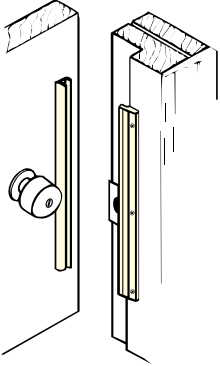

ILP206 / ILP212

The INTERLOCK for inswinging doors

- 6" version for use with key-in-knob and deadbolt locks
- 12" version for use with Mortise Locks, Simplex 1000 series, Alarm Lock DL-2500, DL-2700 & 3000, Card Access Systems, etc.

Stocked Product

ILP206 6"
ILP212 12"

Finishes:
DU (Duro Coated)
SL (Silver Coated)

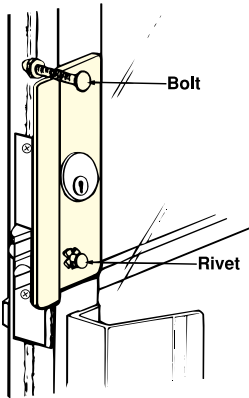

LP307

For ALUMINUM ENTRANCE doors

- Reversible
- Fits over cylinder - lock removal NOT required
- Hand carriage bolt and rivet supplied
- No specific tools required
- 3/8" offset, Display Package Size - 4" x 12"

Stocked Product

LP307 2-5/8" x 7" x 3/8"

Finish:
SL (Silver Coated)
630 (Stainless)

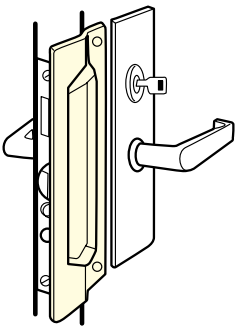

MLP111 / MLP211

For OUTSWINGING DOORS - completely covers the strike plate

- Furnished with carriage bolts, washers & acorn cap nuts for safety and strengths

Stocked Product

MLP111 3" x 11"
Finish: 630 (Stainless)

MLP211 3" x 11"
Finish: SL (Silver Coated)

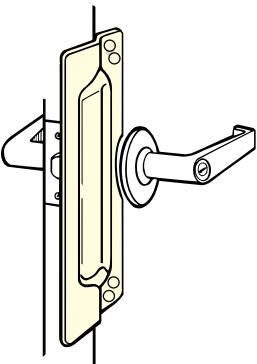

LP111 / LP211

For Outswinging Doors Completely Covers Strike Pate

- Furnished with carriage bolts, washers & acorn cap nuts for safety and strength
- Fits 2 3/4" and 2 3/8" backsets

Stocked Product

LP111 3" x 11"
Finish: 630 (Stainless)

LP211 3" x 11"
Finish: DU (Duro Coated)
Finish: SL (Silver Coated),



Don-Jo Lock Guard Plates

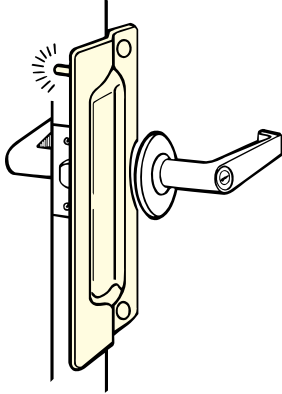

PLP111 / PLP211

Pin Latch protectors for OUTSWINGING DOORS

- Solid steel pin prevents spreading of door from frame
- Pin is welded on back leaving no visible point of attack from outside
- Fits 2 3/4" and 2 3/8" backsets

Stocked Product

PLP111 3" x 11"
Finish: 630 (Stainless)

PLP211 3" x 11"
Finish: 626

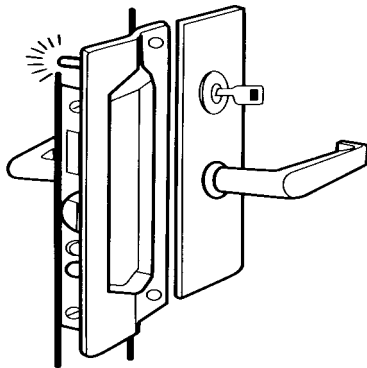

PMLP111

Pin Latch protectors for OUTSWINGING DOORS

- Solid steel pin prevents spreading of door from frame
- Pin is welded on back leaving no visible point of attack from outside

Stocked Product

PMLP111 3" x 11"
Finish: 630 (Stainless)

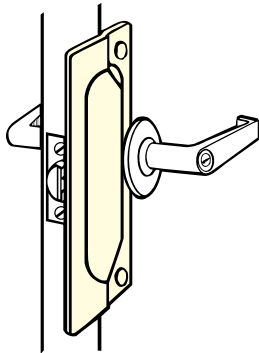

LP107 / LP207

For OUTSWINGING DOORS

- Furnished with carriage bolts, washers & acorn cap nuts for safety and strength

Stocked Product

LP107 2-3/4" x 7"
Finish: 630 (Stainless)

LP207 2-3/4" x 7"
Finishes:
DU (Duro Coated)
SL (Silver Coated)

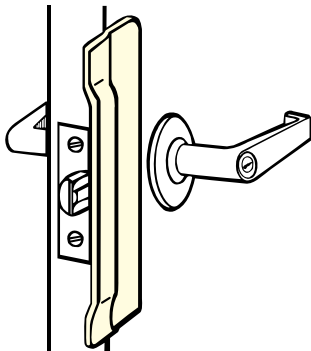

CLP110

For COMMERCIAL TYPE for outswinging doors

- 6" for key-in-knobs
- 10" for Mortise Locks
- Architectural design
- Concealed welded studs with fasteners

Stocked Product

CLP110 2-1/8" x 10"
Finish: 630 (Stainless)



Don-Jo Lock Guard Plates

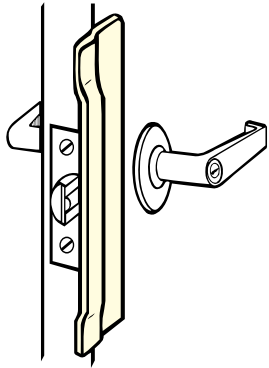

NLP-210 NARROW COMMERCIAL TYPE for outswinging doors

- 6" for key-in-knobs
- 10" for Mortise Locks
- Narrow type for outswinging doors

Stocked Product

NLP210 1-1/2" x 10"

Finish: SL (Silver Coated)

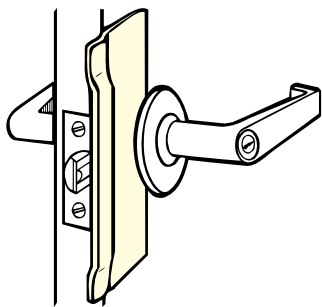

BLP107/BLP207 For KEY-IN-LEVER Locks with up to 3-3/4" ESCUTCHEON

- Works with up to 3 3/4" rose
- Concealed welded studs with fasteners

Stocked Product

BLP107 3-1/4" x 7"

Finish: 630 (Stainless)

BLP207 3-1/4" x 7"

Finish: SL (Silver Coated)

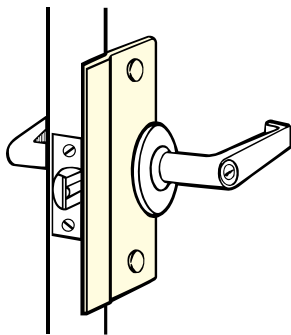

SLP206 SHORT TYPE for outswinging doors

- Furnished with carriage bolts, washers & acorn cap nuts for safety and strength
- May be used on hollow metal door/frame using ANSI strike
- Works with up to 3 3/4" roses

Stocked Product

SLP206 2 5/8" x 6"

Finishes:

DU (Duro Coated)

SL (Silver Coated)

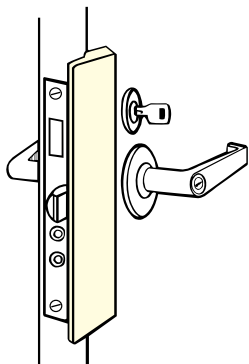

LP2878 SLIMLINE for outswinging doors

- Fasteners included
- Sleek appearance

Stocked Product

LP2878 1-1/2" x 8-7/8"

Finish:

SL (Silver Coated)



Don-Jo - Decal

Decal



HD-1
4" x 4"
White on Blue

THIS DOOR TO REMAIN UNLOCKED DURING BUSINESS HOURS

DD-1/DD-2

THESE DOORS TO REMAIN UNLOCKED DURING BUSINESS HOURS

DD-3/DD-4

1 1/2" x 24"

DD1 Black on Clear
DD2 White on Black

DD3 Black on Clear
DD4 White on Black

THIS DOOR TO REMAIN UNLOCKED WHILE BUILDING IS OCCUPIED

DD-5/DD-6

THESE DOORS TO REMAIN UNLOCKED WHILE BUILDING IS OCCUPIED

DD-7/DD-8

1 1/2" x 24"

DD5 Black on Clear
DD6 White on Black

DD7 Black on Clear
DD8 White on Black



Don-Jo - Architectural Accessories

#K0050

ANSI J102 Metal

Used on doors subject to marring or damage from foot traffic.

ANSI

COMMERCIAL KICK PLATES

- Individually packaged with screws
- Fully threaded to the head stainless steel sheet metal screws plated to finish
- Beveled, 4 edged (B4E)
- Commercial grade thickness
- Kick plate screws only
Specify 9DJOKPS + FINISH

Stocked Product

P/N	Size	Finishes
K0050	6" x 34"	630
K0050	8" x 30"	630
K0050	8" x 34"	605, 613, 630
K0050	10" x 30"	630
K0050	10" x 32"	630
K0050	10" x 34"	605, 613, 628, 630
K0050	10" x 40"	605, 613, 630
K0050	10" x 46"	630
K0050	12" x 34"	630
K0050	36" x 34"	630
KPS605	Kickplate screws 605, 613, 630	

ARMOR PLATES

- Commercial grade thickness
- Stainless Steel 630
- 36"x 34" Stock

KICK PLATE

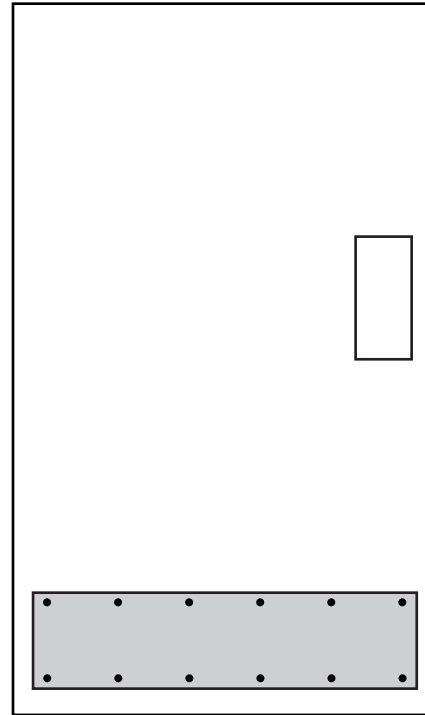

ARMOR PLATE

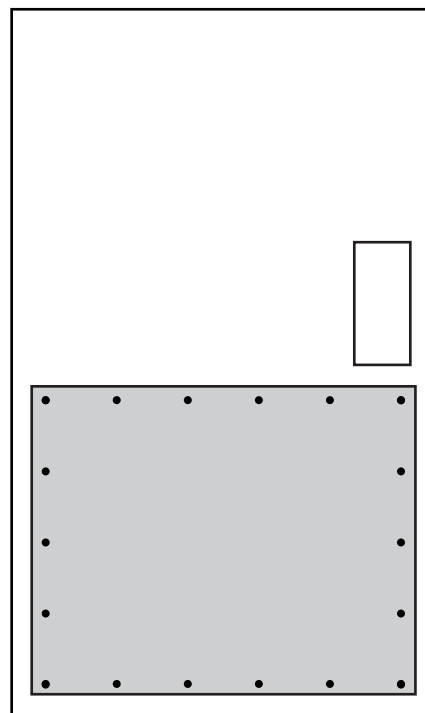



Don-Jo Wrap Around

The Classic Wrap-Around advantage

22(.32) Gauge

includes:

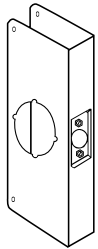
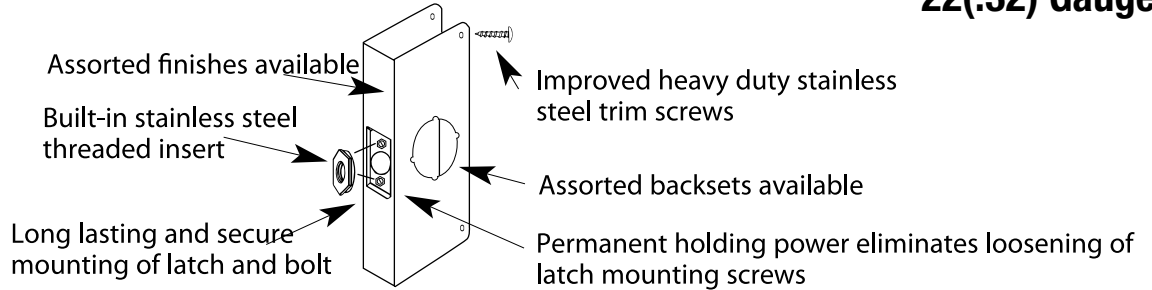

Model 3

For **CYLINDRICAL DOOR LOCKS** with 2 1/8" hole

#	BACKSET	DOOR	DIMENSIONS
3	2-3/4"	1-3/8"	4-1/4" x 9"

Stocked Product

Finishes:
Polished Brass (PB)
Stainless Steel (S)

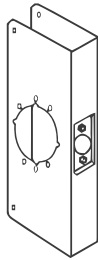

Model 4-2

For use with **Heavy Duty Grade 1 & Grade 2 Key-in Levers**

#	BACKSET	DOOR	DIMENSIONS
4	2-3/4"	1-3/4"	4-1/4" x 9"

Stocked Product

Finishes:
Stainless Steel (S)

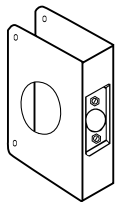

Model 8

For **DEADBOLTS** with 1 1/2" hole

BACKSET	DOOR	DIMENSIONS
2-3/4"	1-3/4"	4-1/4" x 4-1/2"

Stocked Product

Finishes:
Polished Brass (PB)
Stainless Steel (S)

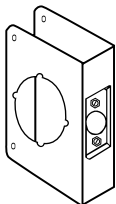

Model 61, 81

For **CYLINDRICAL DOOR LOCKS** with 2 1/8" hole

#	BACKSET	DOOR	DIMENSIONS
61	2-3/8"	1-3/4"	4" x 4-1/2"
81	2-3/4"	1-3/4"	4-1/4" x 4-1/2"

Stocked Product

Finishes:
Polished Brass (PB)
Stainless Steel (S)

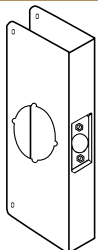

Model 12

For **CYLINDER DOOR LOCKS** with 2 1/8" hole,
12" height

BACKSET	DOOR	DIMENSIONS
2-3/4"	1-3/4"	4-1/4" x 12"

Stocked Product

Finishes:
Polished Brass (PB)
Stainless Steel (S)



Don-Jo Wrap Around

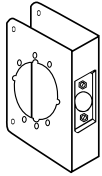

Model 81-2

For use with **HEAVY DUTY GRADE 1 & GRADE 2 key-in-levers**

BACKSET	DOOR	DIMENSIONS
2-3/4"	1-3/4"	4-3/4" x 4-1/2"

Stocked Product

Finishes:
Polished Brass (PB)
Stainless Steel (S)

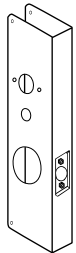

Model 15

Fits **SIMPLEX/UNICAN 1000 SERIES & 4000 SERIES**

BACKSET	DOOR	DIMENSIONS
2-3/4"	1-3/4"	5" x 15"

Stocked Product

Finishes:
Stainless Steel (S)

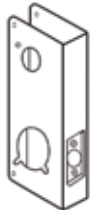

Model 5000

Fits **SIMPLEX/UNICAN 5000 SERIES**

BACKSET	DOOR	DIMENSIONS
2-3/4"	1-3/4"	5" x 15"

Stocked Product

Finishes:
Stainless Steel (S)

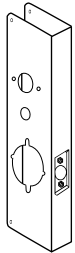

Model 27

Fits **ALARM LOCK 2700/T2 & 3000 SERIES TRYOLOGY LOCK**

BACKSET	DOOR	DIMENSIONS
2-3/4"	1-3/4"	5" x 15"

Stocked Product

Finishes:
Stainless Steel (S)

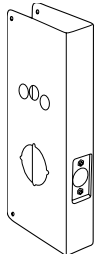

Model 18

Fits **SCHLAGE COBRA LOCKS**

BACKSET	DOOR	DIMENSIONS
2-3/4"	1-3/4"	5" x 15"

Stocked Product

Finishes:
Stainless Steel (S)



Model 504

MORTISE LOCK wrap-around plate for 86 cut-out

BACKSET	DOOR	DIMENSIONS
-	1-3/4"	5" x 12"

Stocked Product

Finishes:
Stainless Steel (S)